

# **SONICATOR**

## **ULTRASONIC PROCESSOR**

Part No. S-4000

### **OPERATION MANUAL**



**QSONICA, LLC.** *manufacturers of*  
MISONIX SONICATORS

**53 Church Hill Road  
Newtown, CT 06470**

**203.426.0101 tel  
203.426.7026 fax  
info@sonicator.com**

**www.sonicator.com**

## Table of Contents

<u>Section</u>	<u>Page No.</u>
1. Warnings	4
2. Specifications	5-6
3. Principles of Operation	7
4. Description of Components	8-10
5. Preparation for Use (Getting Started)	11-14
6. Operating Instructions	15-24
7. Accessories	25-26
8. Sound Reducing Enclosure	27-29
9. Techniques for Optimizing Results	30
10. Maintenance	31-36
11. Troubleshooting	37-38
12. Warranty	39
13. Return of Equipment	40
14. Instructions for Specialty Horns	41-55
a. Cup Horn	41-43
b. Microplate Horn	44-49
c. Flocells™	50-53
d. Dual Horn	54-55

Please read the manual in its entirety. The new digital Sonicator offers several new and innovative features. This manual provides the necessary instruction and guidance to help ensure the successful operation of this device.

## **1. Warnings**

Your new Ultrasonic Liquid Processor has been designed, built and tested to assure maximum operator safety. However, no design can completely protect against improper use that may lead to bodily injury and/or property damage. For total safety and equipment protection, read the instruction manual carefully before attempting to operate this equipment. Observe the following **WARNINGS**:

- High voltage is present in the generator (power supply), converter and high frequency cable. There are no user-serviceable parts inside any of these devices. Do NOT attempt to remove the generator cover or converter case.
- Do NOT touch any open cable connections on the unit while the power is turned ON.
- Do NOT operate generator with converter disconnected from high voltage cable. High voltage is present in the cable and may pose a shock hazard.
- Do NOT attempt to disconnect the converter high voltage cable while the unit is running.
- The generator must be properly grounded with a 3-prong plug. Test electrical outlet for proper grounding before plugging in unit.
- Install the SONICATOR® in an area free from excessive dust, dirt, explosive or corrosive fumes and protected from extremes in temperature and humidity. Do not place the Generator within a Fume Hood.
- NEVER immerse the converter in liquids of any kind, or let condensed moisture or liquid drip into the converter.
- NEVER grasp an activated horn or touch the tip of a vibrating probe. It can cause severe burns and tissue damage.
- NEVER hold or clamp the converter by the front driver (black portion) or by the horn itself. This can cause permanent damage to the system. Support the converter by only clamping around the converter case.
- Do NOT allow the tip of a vibrating horn or probe to touch the counter top or any other hard surface. It could damage the probe, overload the generator, or damage the surface.
- Avoid touching the bottom or sides of a glass or plastic container with an activated probe. It could crack or shatter the glass or melt the plastic.
- Turn OFF the power switch, unplug the generator and disconnect the power cord from the back of the generator before attempting to replace the fuses.
- Inspect high frequency cable for cracks in the protective outer jacket.
- Do not operate unit with a damaged cable. Doing so may cause serious injury.
- In case of AC power loss, wait 3 minutes minimum before reapplying power.
- Do not turn off AC mains power while running a horn. Stop sonication through the touch screen prior to removing AC power.

### **Symbols**



Caution, Risk of electric shock, Hazardous voltage.





Caution, Risk of danger. Refer to User Manual.

## **2. Specifications**

Input Voltage	100 VAC -240 VAC @ 50/60 Hz
Rated Current	100 VAC – 120 VAC, 7 Amps max. 220 VAC – 240 VAC, 3.5 Amps max.
Fuse Rating	For 100 VAC – 120 VAC, 8 Amps (Fast Acting)* For 220 VAC – 240 VAC, 4 Amps (Fast Acting)*
Weight	13.5 lbs. (6.1Kg)
Dimensions	11"W x19.5"L x 5.25"H 27.9cm x 49.5cm x 13.3cm
Output Voltage	1000 V rms (max.)
Output Frequency	20 KHz (nom.)

<b><u>Converter</u></b>	
Weight	2 lbs. (0.9 Kg)
Dimensions	8" L x 2.5" Dia. (20.3cm x 6.4cm)
Materials	Aluminum

<b><u>Standard ½" Horn</u></b>	
Weight	0.5 lbs. (0.45Kg)
Dimensions	5" L x1.5" Dia. (12.7cm x 3.8cm)
Materials	Titanium Alloy

<b><u>Environmental</u></b>	
Pollution Degree	2
Installation Category	II
Operating Limits	Temperature: 39 - 95°F (4 - 35 °C)** Relative Humidity 20 - 90% (Non Condensing)
Shipping/Storage	Temperature: 35 -120 °F (2 - 49 °C) Relative Humidity 10 - 95% (Non Condensing) Ambient Pressure Extremes: 40,000 ft.
Restriction of Hazardous Substances (ROHS)	
Relative humidity	Maximum relative humidity 80% for temperatures up to 31°C decreasing linearly to 50% relative humidity to 40°C
Other	For indoor use only
<b><u>Regulatory</u></b>	
UL, CUL, CE	Evaluated to UL 61010-1: 2 <sup>nd</sup> edition, IEC 61010-1, CAN/CSA – C22.2 No. 61010-1 second edition (IEC 61010-1, Mod)  

\*Only use IEC approved Fast acting fuses, Cooper Bussman series S500.

\*\*At low temperatures the screen contrast may require adjustment. See Option menu.

**The Power Cord supplied with the Sonicator must be used.** If the 220V plug is not configured to match the wall receptacle, a properly grounded universal AC socket adapter must be added.

Important: Universal adapters do not convert voltage or frequency. QSonica is not responsible for damage caused by the use of an improper power cord or adapter. Transformers are not recommended.



**WEEE Statement**

This product contains electrical or electronic materials. The presence of these materials may, if not disposed of properly, have potential adverse effects on the environment and human health. Presence of this label on the product means it should not be disposed of as unsorted waste and must be collected separately. As a consumer, you are responsible for ensuring that this product is disposed of properly. To find out how to properly dispose of this product contact Customer Service at [info@sonicator.com](mailto:info@sonicator.com).

### **3. Principles of Operation**

The ultrasonic electronic generator transforms AC line power to a 20 KHz signal that drives a piezoelectric converter/transducer. This electrical signal is converted by the transducer to a mechanical vibration due to the characteristics of the internal piezoelectric crystals.

The vibration is amplified and transmitted down the length of the horn/probe where the tip longitudinally expands and contracts. The distance the tip travels is dependent on the amplitude selected by the user through the touch screen pad. As you increase the amplitude setting the sonication intensity will increase within your sample.

In liquid, the rapid vibration of the tip causes cavitation, the formation and violent collapse of microscopic bubbles. The collapse of thousands of cavitation bubbles releases tremendous energy in the cavitation field. The erosion and shock effect of the collapse of the cavitation bubble is the primary mechanism of fluid processing.

The probe tip diameter dictates the amount of sample that can be effectively processed. Smaller tip diameters (Microtip™ probes) deliver high intensity sonication but the energy is focused within a small, concentrated area. Larger tip diameters can process larger volumes, but offer lower intensity.

The choices of a generator and horns/probes are matched to the volume, viscosity and other parameters of the particular application. Horns are available for both direct and indirect sonication. The Accessories section has more information on this subject.

Ultrasonic processors have proven to be highly effective for many applications including:

- Cell disruption
- Nanoparticle dispersion
- Homogenization
- Shearing DNA
- Disaggregation
- Focused cleaning
- Mixing
- Degassing
- Catalyzing reactions

Please consult with a QSonica product specialist for help with selecting the proper generator and horn for your application.

## **4. Description of Major Components**

### **Generator**

The Generator supplies a 20 KHz electrical signal to the converter. The S-4000's advanced digital signal processing tracks frequency changes in the Probe-Converter Assembly caused by load and temperature changes, and maintains maximum electrical efficiency at all times.

The Generator also incorporates an enhanced digitally controlled automatic gain feature that maintains the amplitude selected by the user. As the Probe is loaded, the S-4000 will automatically supply greater power (wattage) to the Converter, thereby keeping the amplitude constant. Amplitude, which is the distance the Probe's tip moves out from rest and back in each cycle, determines the level of sonication.

The S-4000 also contains a self test and diagnostic feature that acts as a signal analyzer in determining the integrity of the system. The S-4000 is equipped with fault detection circuits that protect the generator from overloads due to defective converter / probe assemblies. The self test and diagnostic feature can be activated following an error condition to assist the user in remedying the fault or from one of the menu screens.

Also employed in this design is a LCD touchscreen user interface that contains easy to use menus for the control and operation the system. The S-4000 can either be controlled manually or automatically through user defined programs. Output amplitude can be set from 1% -100% giving a greater degree of resolution for setting the amplitude needed to effectively process samples. Reference information such as converter power output, joules, and process time is also displayed.

Incorporated into the S-4000 is a universal power supply that recognizes any AC mains voltage throughout the world. The back panel of the S-4000 contains Mains power inlet and fuse drawer, high voltage BNC connector for the converter cable, footswitch and K-type temperature probe input connectors. In addition, a USB input connector is available for easy field software upgrades.

### **Converter (also known as the Transducer)**

The converter consists of a cylindrical unit (mounting area), and black colored front driver (the first stage of acoustic amplification) with a threaded hole for horn attachment. The generator supplies a 20 KHz electrical signal to the converter. The Converter changes the signal to mechanical vibration.

### **Horn (also known as the Probe)**

A horn is an approximately 5" long resonant body that steps down from 1.5" diameter to a specific tip diameter. The horn serves as the second stage of acoustic amplification. The horn may be solid or have a removable tip and is supplied with a threaded stud for attachment to the converter and external threads around the body for attachment to other accessories. Horns are available in three standard tip diameters of 1/2", 3/4" or 1" and come in three different tip configurations. Tapped horns have a replaceable Flat Tip; Solid horns are one solid piece and do not have a replaceable tip; and Sapphire tipped horns have a 1/16" thick sapphire disk bonded to the tip of a solid horn.

The # S-4000 includes a standard 1/2" diameter tapped horn (#200).



**S-4000 Rear Panel**

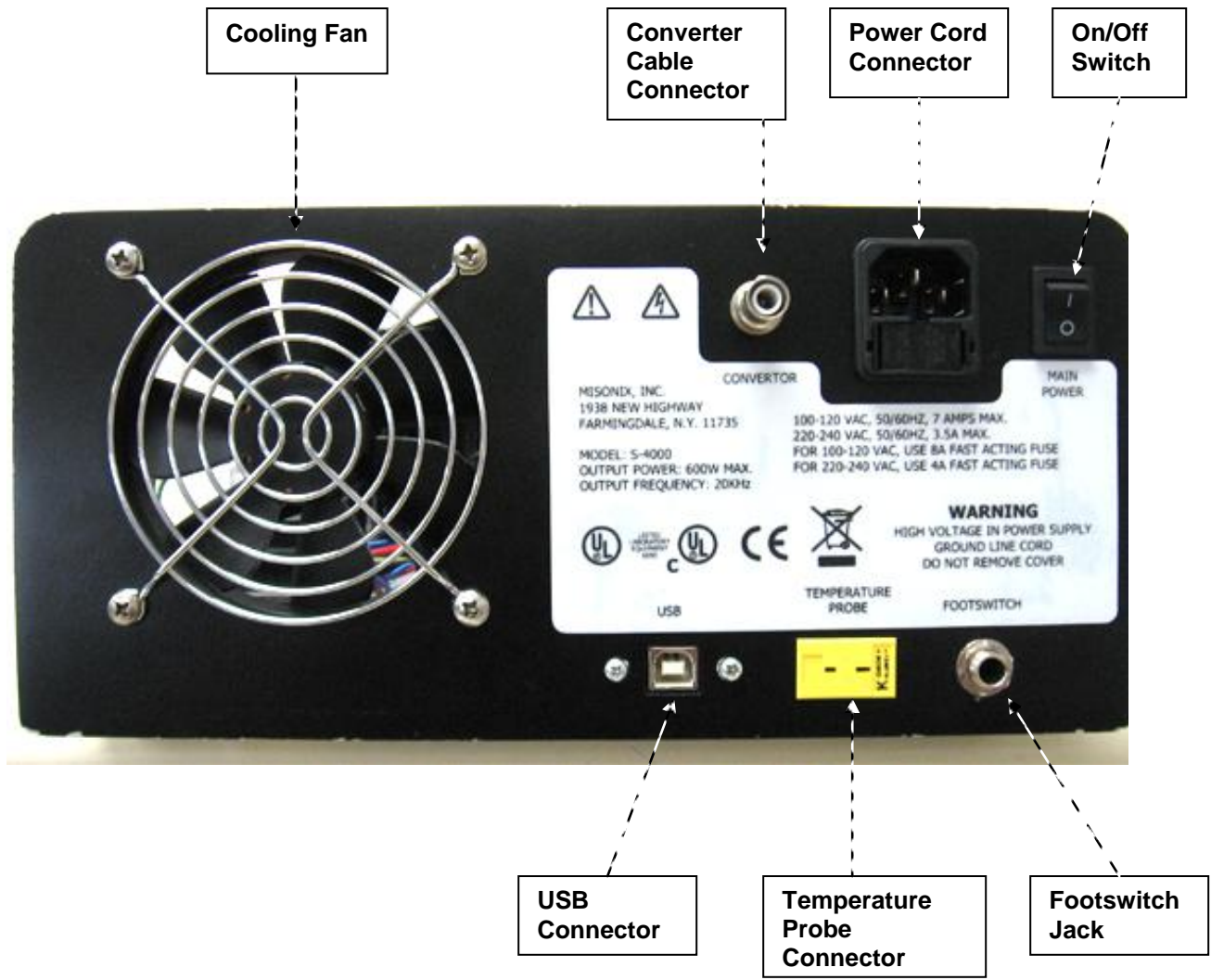

## **5. Preparation for Use (Getting Started)**

- To safeguard the fuse against failure, always switch the power supply off before connecting or disconnecting the power cord.
- The power cord supplied by QSonica must be used. If it does not match your wall outlet, use the appropriate universal adapter for your specific country.
- Check to make sure that the Power Switch on the back of the generator is switched OFF.
- Connect the Power Cord to the receptacle on the rear of the generator and plug it into a grounded power outlet.
- **Horns must be properly tightened.** Depending on the accessories purchased, often the horn and the flat tip are attached to the converter at the factory. **Check the tightness of the horn and flat tip by using the wrench set.** Please refer to images on page 12 of this manual. A loose horn or tip may cause damage to the generator circuitry or parts of the converter and horn. A loose horn may also show a fluctuation in wattage readings. Never assemble or disassemble the probe by holding the converter in a vise or while power is on. **Always use the wrenches supplied with the unit.**
- When replacing horns or horn tips, clean the mating surfaces of the converter and horn as well as the threaded stud and hole. Check that the stud is tight. **Do not** apply grease or RTV to mating surfaces or threads of the converter, horn or replaceable tip.
- Mount the converter using the Sound Enclosure (**#432B**), Converter Stand and Positioner (**#438**) or a secure clamp.



**Sonicator with converter and horn mounted on # 438 Stand**

## Attaching and Detaching Horns

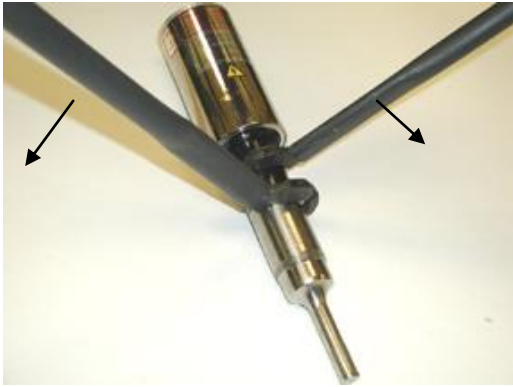

Horn Removal

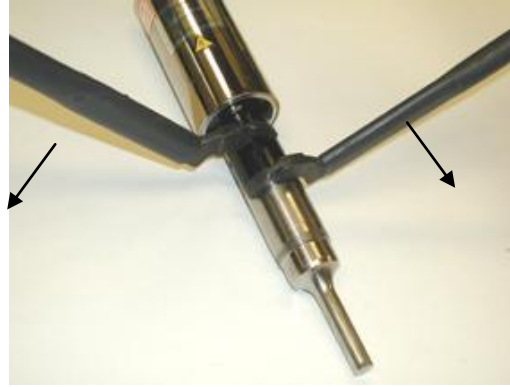

Horn Tightening

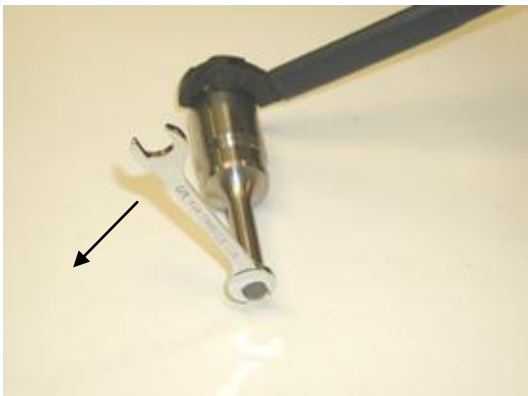

Tip Removal

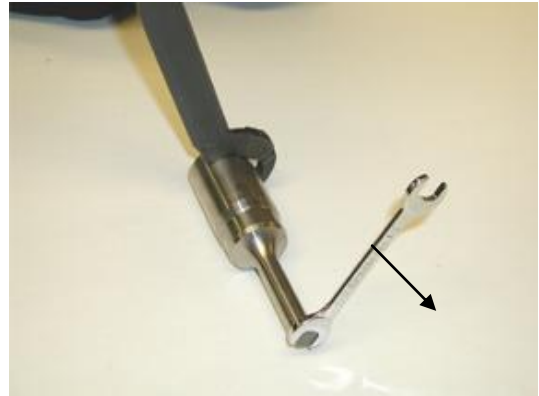

Tip Tightening



Microtip™ Removal



Microtip™ Tightening



Wrench Set

**Note:** When tightening a Microtip™ the tip must not be in contact with the worksurface. Always have the tip extending off the end of the table or worksurface.



1/2" Horn

Microtips™ are attached to the 1/2" Horn after the tip has been removed.

#420 Microtip™ is the only exception to this rule and is attached directly to the Converter.

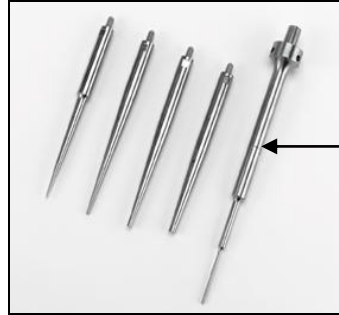

Microtips™

#420

Converter and horn mounted in Sound Enclosure (# 432B).

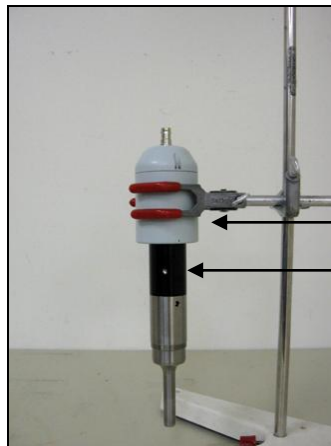

Proper way to clamp a Converter.  
Never clamp on the black area.

- Connect either end of the coaxial high frequency cable to the rear of the generator and the other end to the receptacle on the converter. Push the connectors in and turn the chrome rings clockwise 1/4 turn to secure the connectors.
- If a foot switch or timer switch is used, plug it into the foot switch connector. Make sure that the plug is inserted properly.

- If you will be using a Microtip™ or Extender, remove the flat tip on the end of the horn, then attach the Microtip™ or Extender in its place.
- Horns and probe tips wear after normal usage. Using a severely worn tip can damage internal components. Replace tips when they become pitted. See the Maintenance section for details.
- For best results it is critical to use the appropriate size and type of horn. If you are not sure that you have the proper horn, please call for assistance.
- Low surface tension liquids (solvents) require a solid tip horn.
- Set up regular preventive maintenance schedule. See the Maintenance section for details.
- Hearing protection is highly recommended. The Sound Enclosure (#432B) reduces sonication noise to safe levels. If you decide not to use a Sound Enclosure, earplugs or headphones should be worn.
- If exposed to low temperatures the display may appear dim and difficult to read. Please adjust the contrast to improve the view. Allowing the unit to warm to room temperature is recommended.
- In case of AC power loss, wait 3 minutes minimum before reapplying power.
- Do not turn off AC mains power while running a horn. Stop sonication through the touch screen prior to removing AC power.

## **6. Operating Instructions**

Your new Ultrasonic Liquid Processor has been designed with a color ¼ VGA LCD user interface with touch screen capabilities. All program and run functions are controlled through the touch screen panel.

1. Answer the Microtip™ Question, Yes or No. See page 13 and 25 for an image of a Microtip™. If you are not familiar with the Microtips™ and need assistance, please call QSonica for help.

**Warning:** Improper selection may result in tip damage or poor sonication.

2. Select the Mode of Operation or access Options screen.
  - a. Manual Mode: Selecting Manual Run allows the user to set the sonicator output level manually (setting 1 – 100%). Starting and stopping the ultrasound output is also manually performed.
  - b. Program Mode: Allows the user to program specific On / Off times at any programmed output setting. The ability to save up to 10 programs and sequence several individual programs together can also be performed in this mode.
  - c. Options: Allows the user either select footswitch mode of operation, change display contrast, and select either °C or °F if temperature monitoring is enabled. Footswitch and temperature probes are optional items and are not shipped unless specifically ordered with the unit.

In addition, the Sonicator has diagnostic capabilities. In the event of a fault, an appropriate message will appear and give instructions to perform a diagnostic test. It is recommended to perform the diagnostic test each time a fault occurs in order to resolve the problem.

Please review the sample screens and information on the following pages for assistance with operating the Sonicator.

**Operating Instructions** (continued)

This is the opening screen that momentarily appears after Sonicator is switched On.

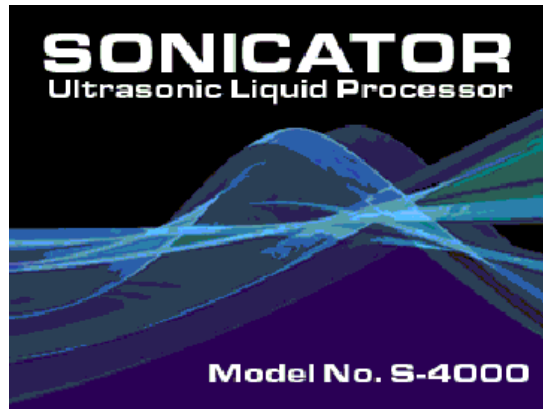

The following screen then appears:

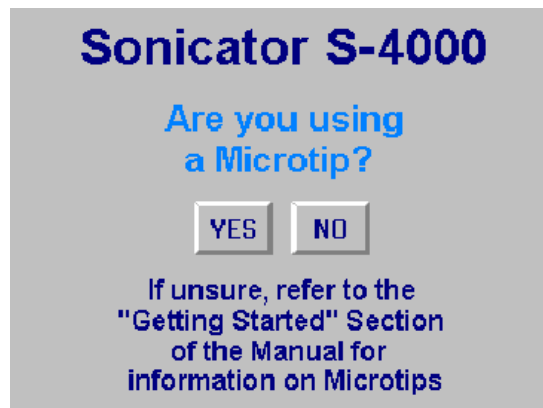

When using a Microtip™, the YES button must be selected.

**Warning:** Improper selection will result in tip damage or poor sonication. Damage caused by not following this step is not covered under the warranty.

Please refer to **Accessories** (section 7) for information on Microtips™.

After answering this question, the following screen appears:

This screen allows the user to select Manual mode, Program menu, Options screen or Diagnostic test mode.



**Manual Mode** – This mode allows the user to manually start and stop sonication at any amplitude setting between 1-100%.

**Program Menu** – This mode allows the user to create a program, select or run a program and select or run a sequence of programs.

**Option Screen** - The Option menu allows for the selection of Temperature units, Footswitch operational modes and Display contrast.

**Diagnostic Test** – The Sonicator is equipped with self-diagnostic capabilities. Detailed information can be found in section 11 (Troubleshooting).

The following screen displays the **Manual Mode**.

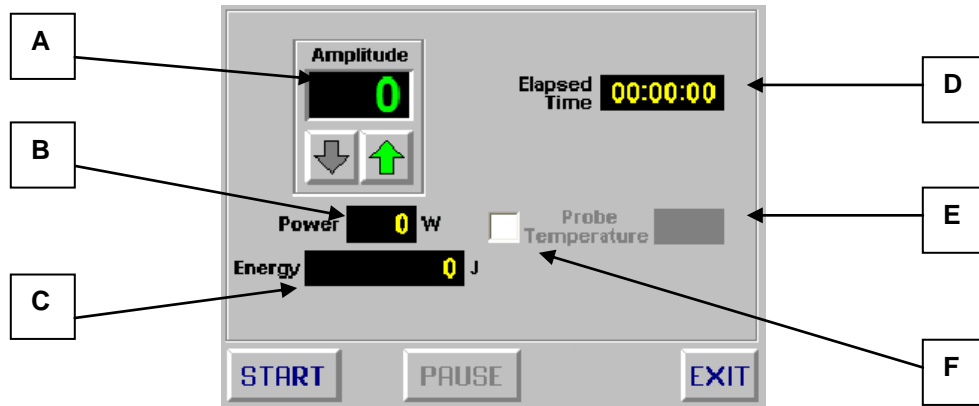

- A. Amplitude (intensity) setting - Output amplitude may be set between 1-100%.
- B. Power displayed in Watts.
- C. Energy displayed in Joules.
- D. Elapsed Time – Total time of active sonication.
- E. Temperature probe measurement (note: if “OPN” appears, it indicates temperature monitoring has been activated but the probe is not connected).
- F. Temperature probe On/Off indicator. Touch the box to activate temperature monitoring. A check mark will appear indicating that temperature monitoring is activated.

Select the appropriate Amplitude (intensity setting) for your sample by touching the Up or Down arrow. Touch Start to begin sonication. Touch Pause to pause sonication.

Manual and Program modes both show the Start, Pause and Exit buttons. After touching the Start button and activating sonication, the Start button becomes a Stop button. After touching the Pause button, the Pause button becomes the Resume button.

If sonication is stopped, Energy and Elapsed Time values remain on display. If the Start button is touched again, the values are reset. If sonication is Paused and Resumed, the Energy and Elapsed time data will resume counting from the point at which it was paused.

The Temperature Probe option can be selected if you wish to monitor the temperature of the sample being processed.

## Program Menu

The unit can be programmed to sonicate at specific, user-selected time intervals including pulse mode.

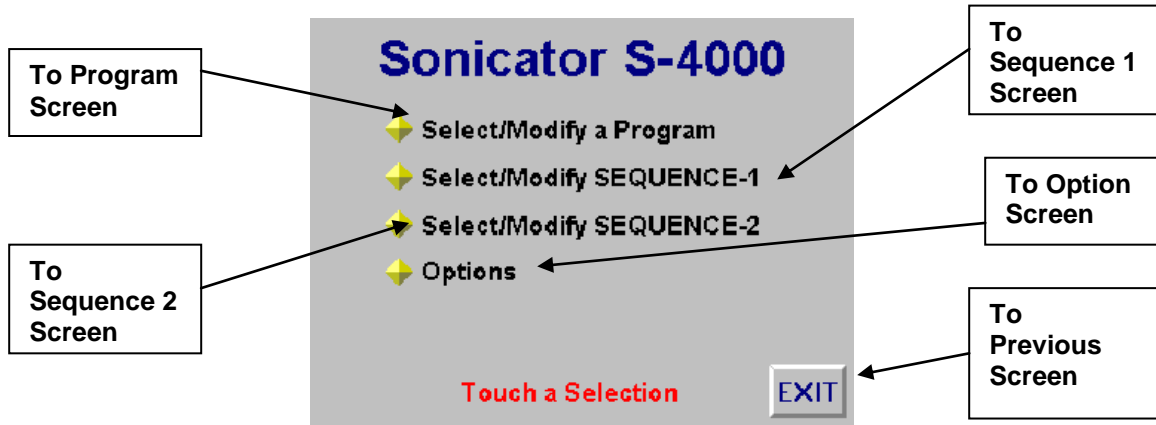

**Select/Modify a Program** – Create, select or modify up to 10 different programs.

**Select/Modify Sequence 1 & 2** – Select a sequence of programs for the unit to run in succession. A maximum of 6 programs can be sequenced at one time.

**Option Screen** - The Option menu enables the selection of Temperature units, Footswitch operational modes and Display contrast.

## Programming Screen



### How To Create a Program

The Sonicator has the ability to save up to 10 programs.

1. Select a program number from the keypad, the program number will appear above the Amplitude box.

**For each of the following steps:** After touching a field, the background will change to yellow indicating an active field. After entering data, the entry is completed by touching Enter (ENT), touching the field a second time or by touching a new field.

2. Program a value into the Amplitude field.
3. Program total Process Time (total active sonication time).
4. Program Pulse On time – If no data is entered (00hr:00min:00sec), the unit will run continuously without pulsing.
5. Program Pulse Off time – If no data is entered, the unit will run continuously without pulsing.

Process Time, Pulse On and Pulse Off times are measured in Hours: Minutes: Seconds format.

6. Activate Temperature Monitoring (if necessary).
7. Program a Shutdown Temperature (if necessary). Enter a temperature value. During sonication, if the temperature reaches the Shutdown value, the unit will pause sonication. The unit will remain paused until the temperature drops below the pre-set value. Once the temperature drops below the value, sonication can be manually resumed.
8. Touch Save to store the program to the memory number selected in step 1.
9. Touch Run to proceed to the following screen.

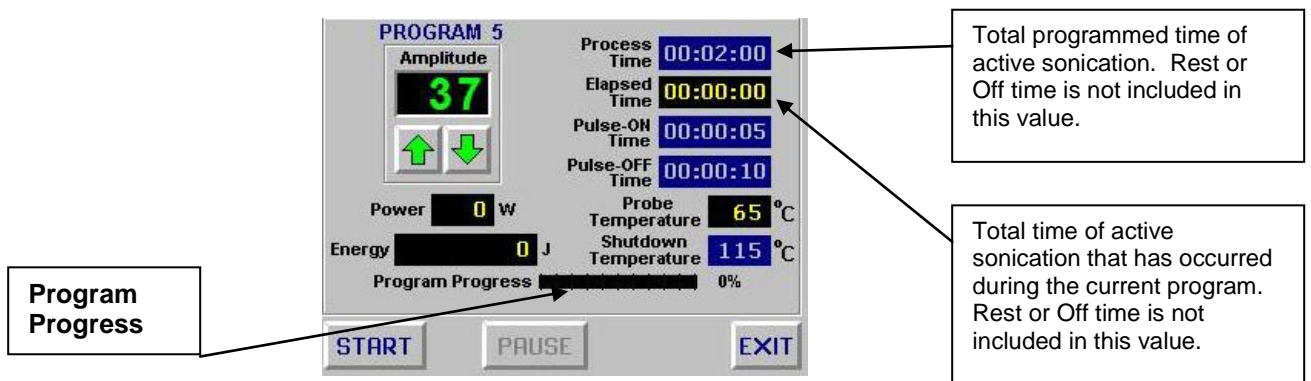

10. Touch Start to begin the program.

## How To Run A Saved Program

From the program screen (see image at top of previous page), touch the program number on the right side of the screen and the selected program settings will appear.

Follow steps 9 and 10 from the previous page.

This Run screen is an example of a sample program in progress.



The Temperature Monitoring and Shutdown Temperature option have been selected during this example program.

**Program Progress** is displayed by a bar graph. This displays the progress of the current program including both the On and Off time combined.

## Sequencing

After selecting Sequence 1 or 2 from the Program Menu, the following screen will appear:

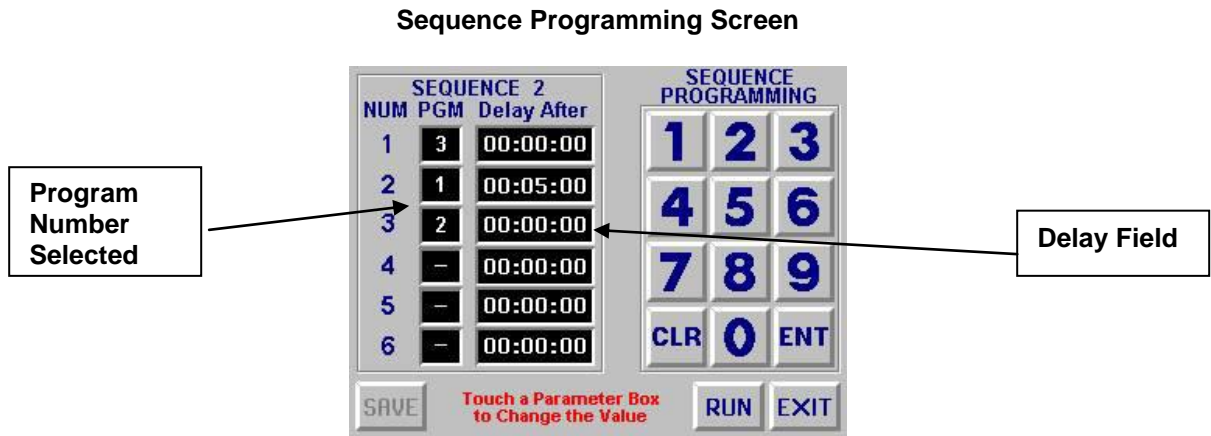

After creating multiple programs, a sequence of those programs may be selected. Select the Program Number and the amount of time desired between Programs. Save the settings and touch Run to begin the sequence of programs.

### How to Create a Sequence

1. Touch the Program (PGM) field, select the appropriate program number and touch ENT.
2. Enter each desired program number in order, in the PGM fields.
3. If a delay or rest time between programs is desired, touch the Delay After field. Enter the appropriate time frame.
4. Unused PGM fields should have a dash (-). Select unused programs, touch CLR and ENT if necessary.
5. The last Delay After field as well as any unused fields should be cleared to 00:00:00 as displayed in NUM 3, PGM 2 as shown above. Select unused fields, touch CLR and ENT if necessary.
6. Touch Save to store the sequence.

### How to Run a Sequence

From the Sequence Program Screen, touch Run, the following screen will appear:



**Sequence Progress Bar** – The measure of the total of all programs in the sequence including On, Off and Delay After times.

The following Option Screen can be accessed from either Menu Screen.

The Option menu enables the selection of **Temperature units**, **Footswitch operational modes** and **Display contrast**.

### Option Screen

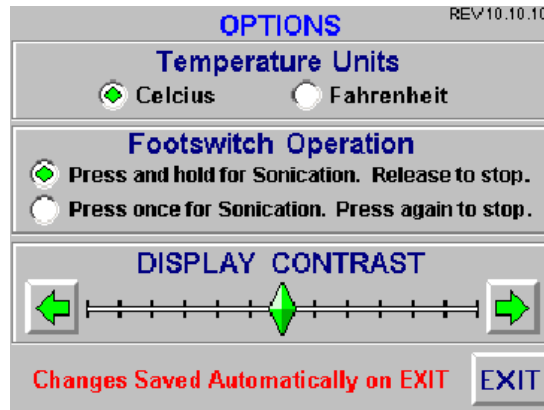

**Temperature Units** – A temperature probe (# TP4000) is required for use of this option.

The Temperature Probe option can be selected if you wish to monitor the temperature of the sample being processed.

The temperature probe must be plugged into the back of the Sonicator and the probe tip must be in the liquid sample. If the initial sample temperature is above the set point, sonication will not turn on. During sonication, if the temperature reaches the Shutdown value, the unit will pause sonication. The unit will remain paused until the temperature drops below the pre-set temperature limit, at which time sonication can be manually resumed.

**Footswitch Operation** – A footswitch (# FS-3) is required for use of this option.

After setting up a program, the footswitch can be used to remotely activate the unit.

**Display Contrast** – The left arrow will lighten the screen, the right arrow will darken the screen.

**Exit** – The Exit button will save changes and return to the previous screen.

## Help Screens

The S-4000 is equipped with fault detection circuits that protect the generator from overloads due to defective converter / probe assemblies. Several Help screens may appear depending on the type of fault detected. Below are two examples. Further details are included in the Troubleshooting section.

<p><b>EXCESSIVE HORN EROSION IS DETECTED</b></p> <ol style="list-style-type: none"><li>1. Disconnect cable from converter.</li><li>2. Replace horn or probe tip.</li><li>3. Re-connect cable to converter.</li><li>4. Press EXIT to return to RUN screen and re-start Sonicator.</li></ol> <p style="text-align: right;"><b>EXIT</b></p>	<p><b>CONVERTER ASSEMBLY FAILURE</b></p> <ol style="list-style-type: none"><li>1. Disconnect cable from converter.</li><li>2. Clean ALL mating surfaces.</li><li>3. Re-tighten using supplied wrenches.</li></ol> <p style="text-align: center;">If problem persists,</p> <ol style="list-style-type: none"><li>4. Replace converter, horn and probe tip.</li><li>5. Re-connect cable to converter.</li><li>6. Press EXIT to return to RUN screen and re-start Sonicator.</li></ol> <p style="text-align: right;"><b>EXIT</b></p>
--	---

The self diagnostic features of this unit apply to all standard horns and Microtips™. Due to certain horn characteristics, specialty horns including Cup Horns and Microplate Horns do not utilize this feature.

**Note:** Do not run a diagnostic test while using a Cup Horn or Microplate horn.

## 7. Accessories

A variety of horns are available to process different sample sizes. Please visit [www.sonicator.com](http://www.sonicator.com) to review tables detailing each horn option and their specific processing volume.

**Direct sonication** (inserting a probe directly into your vessel) is the most popular way to sonicate a sample. This method offers high intensity and effectively processes most samples.

The probe tip diameter dictates the amount of sample that can be effectively processed. Smaller tip diameters (Microtip™ probes) deliver high intensity sonication but the energy is focused within a small, concentrated area. Larger tip diameters can process larger volumes, but offer lower intensity. Probes are offered with either replaceable or solid tips.

Examples of Direct Sonication Horns include:

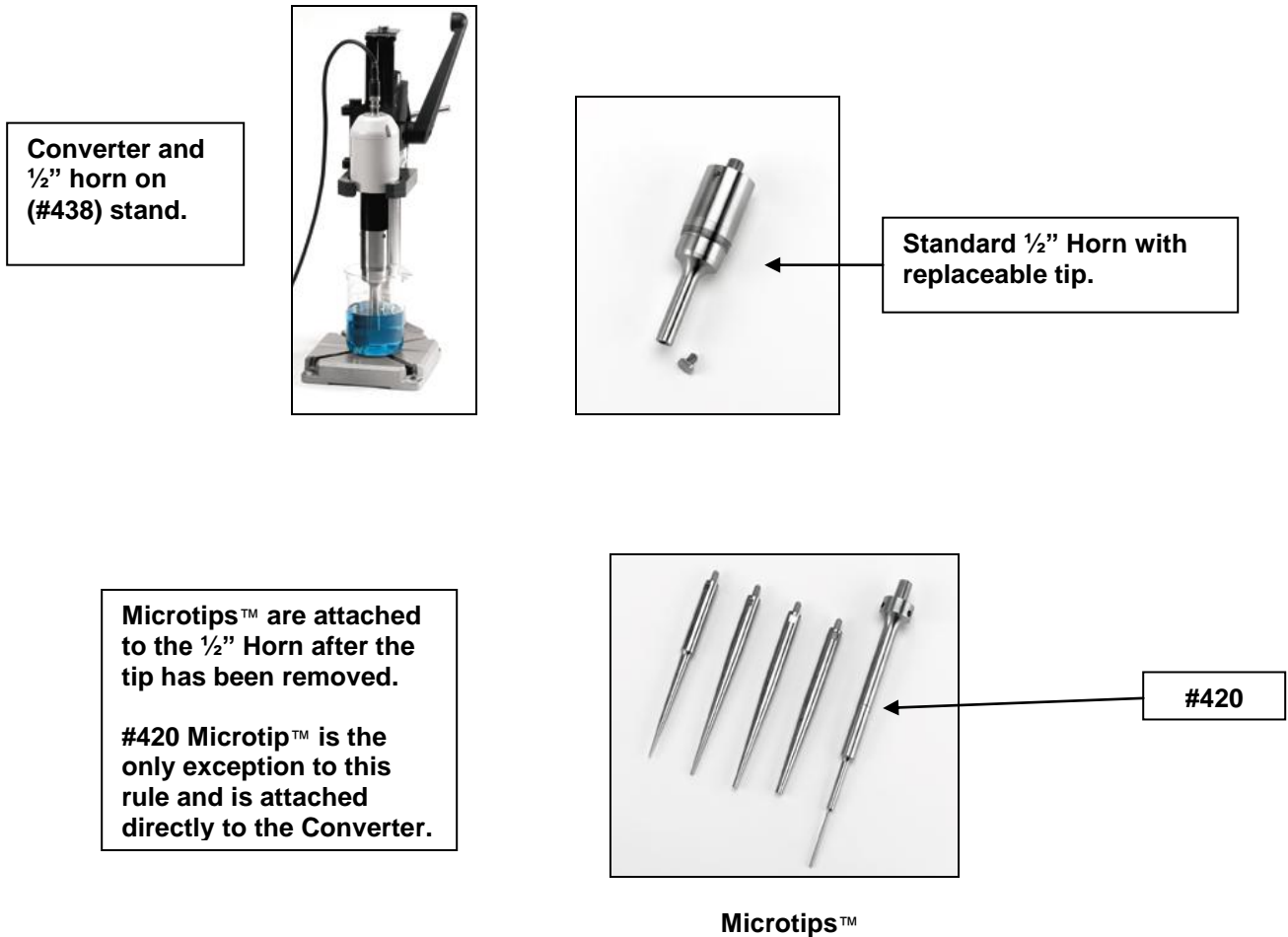



**96 Tip Horn**



**Dual Horn with  
3/4" solid probes**



**Flocell™**

Please refer section 9, **Techniques for Optimizing Results** section for further assistance with direct probe sonication.

**Indirect sonication** eliminates the need for a probe to come in contact with your sample. This technique is often described as a high intensity ultrasonic bath, capable of processing multiple sample vessels at one time.

Indirect sonication is most effective for very small samples because foaming and sample loss are eliminated. Pathogenic or sterile samples are ideal for this method because aerosols and cross contamination are prevented.

The Cup Horn and Microplate Horn deliver indirect sonication. Simply place your microtubes or microtiter plate within the water filled reservoir and the sonic energy is transferred into each individual well. These units are ideal for high throughput applications.

Examples of Indirect Sonication Horns include:



**Microplate Horn**



**Cup Horn**

## **8. Sound Enclosure Instructions**

The Sound Enclosure provides personal protection from the noise generated by ultrasonics. The enclosure reduces sound levels by approximately 25% when compared to sonication done in an open setting. For example, the standard ½” horn produces 90 dB and when used inside the Sound Enclosure, the noise is reduced to 73 dB.

### **A. Standard Horns**



**# 432B**

**For shipping purposes, the unit is assembled with the converter collar inverted and attached by 4 Philips head screws.**

**Remove the screws and lift out the collar. Invert the collar and replace the screws.**

**Now the collar is in the proper position to hold the converter and horn.**

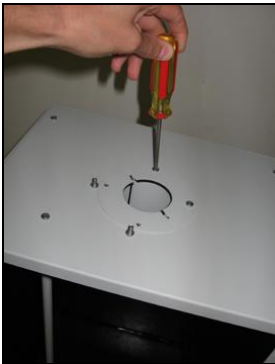

**Remove screws**



**Invert collar**



**Proper installation of horn**



**Standard ½” Horn (# 200) inside Sound Enclosure.**

**Beaker is raised to horn using optional Jack Stand (# 357).**

**Door should be shut and latched before operation.**

Note: A ½” diameter rod is mounted inside the enclosure. A standard laboratory clamp can be used to hold samples if necessary. A clamp is not included with the enclosure.

## B. Cup Horns



**Remove the 4 screws at each corner of the top of sound enclosure.**

**Attach the 2 legs that were shipped inside the enclosure with the rubber feet facing upwards.**

After the legs are attached, rotate the enclosure 180° so it is standing on the legs.

Insert the converter cable up through the hole in the bottom of the box before attaching it to the converter and cup horn. Slowly lower the assembly into the holder making sure the cable is not crimped.

There is a capped port on either side of the enclosure for cold water circulation during sonication. See Section 14 for Cup Horn instructions.

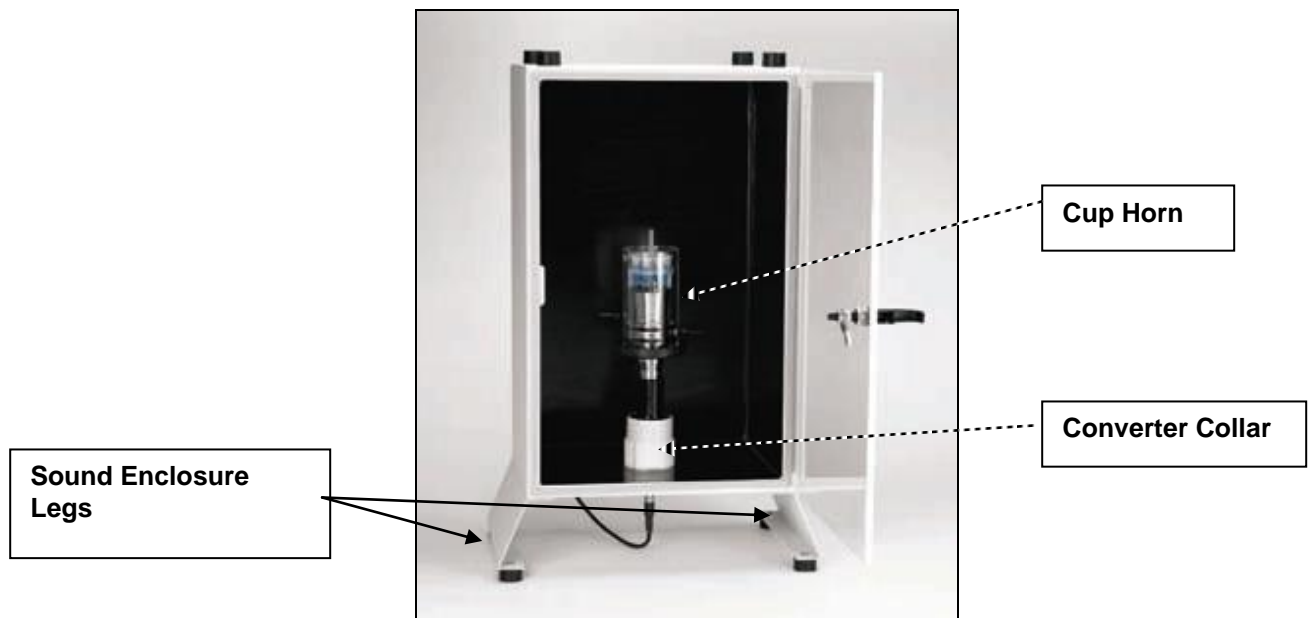

**Proper set up of Cup Horn**

### C. Dual Horns

Prior to operation, the horn and converter must be properly tightened (using the appropriate wrench set) before being inserted into the sound enclosure.



**Remove collar and insert  
converter as shown.**

**Attach collar around  
Converter and secure  
screws.**



**Proper setup of Dual  
Horn is shown.**

## **9. Techniques for Optimizing Results**

### **Probe Depth**

Immerse the probe tip 1.5 times the tip diameter into the solution, without touching the bottom. For example, the ½" horn should be immersed ¾" below the liquid surface. Immersion depth can be less for larger horns and may have to be more for smaller probes used at higher intensity.

### **Foaming and Aerosoling**

Aerosoling and foaming generally occur when the tip is not immersed far enough into the solution. Lowering the tip in the solution, decreasing power, and reducing solution temperature will normally prevent foaming. Lowering the power and increasing sonication time will usually reduce aerosoling; in severe cases, use an aerosol cap or sealed atmosphere treatment chamber. In organic materials, protein release from cell material acts like a wetting agent and tends to promote foaming. For severe foaming:

- Use a narrower processing vessel
- Use a vessel with an irregular inner surface
- Increase effective viscosity by concentration or by adding glass beads.

Once foaming occurs, shut off power or reduce it below cavitation level before proceeding. It may be necessary to use a centrifuge or high vacuum to reduce tenacious foam. If foam persists, the sample may have to be discarded. *If foaming continues to be a problem, an indirect sonication device (such as a Cup Horn or Microplate Horn) may be a better option.*

### **Viscosity Limitations**

Viscous solutions and highly concentrated liquids can be difficult to sonicate. If the liquid is so thick that it will not pour or circulate easily or if 25-micron glass powder will not settle to the bottom quickly, it is too thick and cannot be processed effectively.

### **Keeping Samples Cool**

Intense ultrasonic processing causes the liquid temperature to elevate especially with small volumes. High temperatures reduce cavitation so the liquid should be kept as cold as possible. This can be accomplished by immersing the sample vessel in an ice-salt-water-alcohol bath, or by using a water-jacketed processing vessel with cold water circulation. To minimize temperature elevation, use a pulse mode.

### **Free Radical Information**

Trace free radicals produced by ultrasonics will usually have little or no enzyme activity. The free radicals may be H<sub>2</sub>O<sub>2</sub>, O<sub>3</sub> as well as many other molecules and ions produced from air or water. If this kind of reaction is suspected, it can easily be avoided by using CO<sub>2</sub> or N<sub>2</sub> atmosphere. A CO<sub>2</sub> atmosphere is quickly obtained by placing a pellet of dry ice in the solution before processing and let it "bubble out". A CO<sub>2</sub> atmosphere stops luminescence in the cavitation bubble for the same reason it prevents it in a vacuum tube. It is this luminescence which causes the water and air molecules to break up producing the radicals. This CO<sub>2</sub> procedure, as simple as it is, again is ordinarily unnecessary.

## **10. Maintenance**

Sonicators create high intensity vibration which puts stress on the converter and horn assembly. Regular maintenance is needed to ensure optimum results.

### **WARNING:**

**It is recommended to follow the general maintenance procedure on a regular basis.**

**Never hand tightening tips or horns; properly tighten with the appropriate Wrench Set.**

- Using the wrench set, detach the converter, horn/probe and replaceable tip (page 12).
- Remove the stud from the Horn with a ¼" Allen wrench (not supplied). See page 32. (Note: the stud on a Microtip™ is not removable).
- Clean all mating surfaces, studs and threaded surfaces (use a cotton swab) with isopropyl alcohol and let them air dry. See page 33 and 34.
- Re-attach stud using an Allen key and tightly secure both tip to horn and horn to converter using the supplied wrench set. See page 33.



**Image of a new and a worn tip.**

**Tip on right requires replacement.**

It is recommended to periodically inspect the unit, both visually and physically, to insure optimum and safe performance. This inspection should be scheduled as a routine maintenance procedure, done with the Sonicator power switch in the OFF position, and with the unit unplugged from the AC power source.

Long exposure to acids or caustics results in corrosion of metal parts or components. Check the generator, converter, and cables periodically for any signs of rust or discoloration. If discoloration is found, move the Sonicator away from the source of the contaminant.

Examine the condition of the high voltage cable that attaches the converter to the generator. Inspect the wire insulation for damage, such as wear, burning from hot plate contact or breakage from extended use or rough handling.

Inspect the cable connectors by gently pulling on the wire while holding the metal portion of the connector. The cable connectors and rubber boot protectors at both ends of the cable should be tight to the wire, with no movement possible and no cracks or frayed ends visible. Do not subject the cable ends to severe bending loads while performing these tests. Order a replacement cable immediately if your cable does not pass the above inspection.

### **WARNING:**

**Do not use a cable with broken end connections, exposed wires or frayed insulation.**

**High voltage is present in the cable and will pose a shock hazard. Do not touch the converter assembly until the power switch is off and the unit is unplugged.**

Should the Sonicator display an Error screen, follow the directions on the screen to remedy the fault. See Section 11, Troubleshooting for additional information.

In general use, the cable assembly should not be used to carry the converter or pull it toward the user. Make certain the cable always has slack and is never tensioned. If necessary, move the generator or converter assembly closer to one another to accomplish this. If this is not possible, contact QSonica to obtain a longer cable.

Should the Sonicator stop functioning, shut the unit off and inspect the cable as above **before** any other action is taken.

**Recommended cleaning steps:**

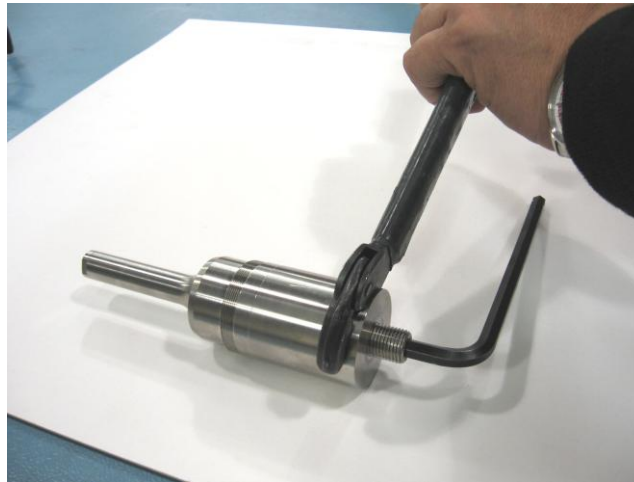

Removing stud from horn

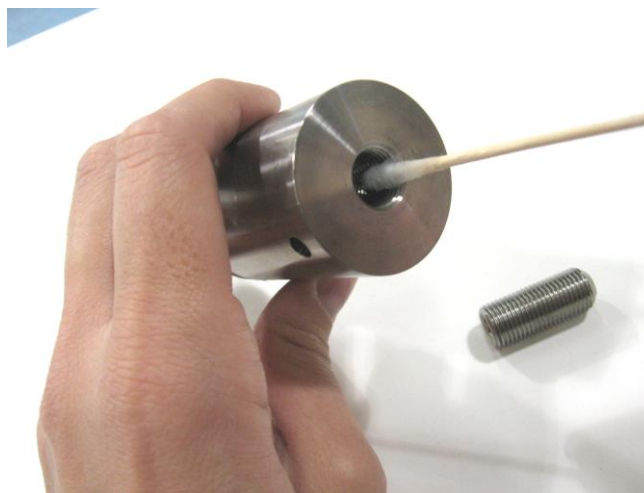

Clean threading inside of horn

Clean threaded Stud



Clean threading in converter. Do not allow liquid to drip into Converter.

Allow parts to dry



Tighten Stud to horn



Cleaning horn stud

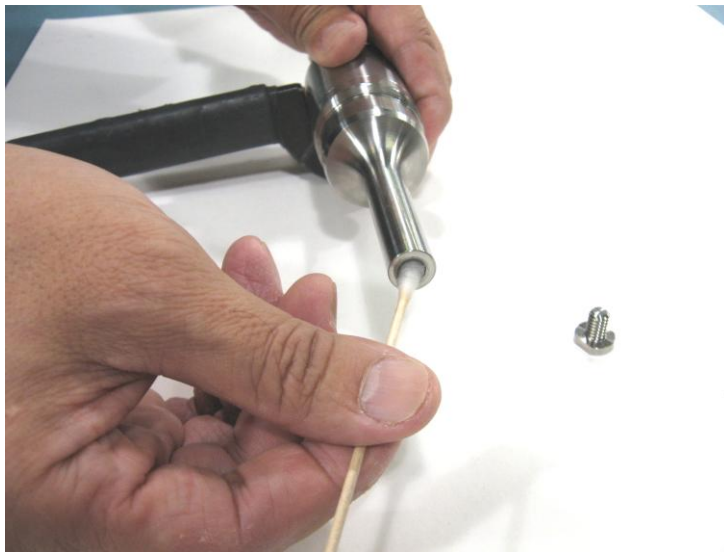

Cleaning horn threading



Cleaning replaceable tip threading

After all connection points have been cleaned, use compressed air (if possible) to ensure all debris has been blown out of the holes. Let the parts air dry.

Re-attach all components tightly.

### **Cleaning Instructions**

The generator and converter may be cleaned using an acid-free cleaning solution (i.e. glass cleaner). Horns and probes should be cleaned using isopropyl alcohol. Horns are made from titanium and can be autoclaved.

### **Tip Care**

The probe tip may be sterilized either by immersing in boiling water, autoclaving, or in a detergent bactericide and a disinfectant (the converter cannot be sterilized). Before each procedure place the probe tip in water or alcohol and turn the power on for a few seconds to remove residue. The tip also can be sterilized using alcohol with the power on. Alcohol is a volatile compound and proper handling precautions must be taken while sterilizing with alcohol.

The sides and end of the probe must **never** be allowed to come in contact with anything but the solution. When using a Microtip™, the stress resulting at the point of contact with the vessel could cause the Microtip™ to fracture. Standard probes may not fracture if they come in contact with the vessel, but can damage the vessel.

Touching a glass vessel wall with the tip will release tiny glass and titanium particles into the sample that may gray the solution. The particles will form a thin dark gray layer on centrifuging but usually have an insignificant effect chemically.

Proper care of the probe is essential for dependable service. The intense cavitation will, after

a prolonged period, cause the tip to erode, and decrease the efficiency of the sonication process without showing up on the power monitor. The smoother and more polished the tip, the more power will be transmitted into the liquid. Any erosion of the probe tip will increase the rate of future erosion. For that reason, it is recommended that after every 5 or 6 hours of use, the tip be examined, and if necessary, polished with a fine emery cloth. Since the probe and tip are tuned to vibrate at a specific frequency, it is important that only the contaminated surface be removed. When changing the tip, check for wear in all mating surfaces. If the horn itself is worn or damaged, replace the horn as well.

## 11. Troubleshooting

The S-4000 is equipped with fault detection circuits that protect the generator from overloads due to defective converter / probe assemblies. In the event of a failure, two types of Error screens, similar to the ones shown below, will appear. If SYSTEM ERROR E1 through E4 appears on the screen, it is recommended to select the DIAGNOSTIC TEST button to start the diagnostic test. The results screen will have step by step instructions to help remedy the problem.

**If the Start button does not initiate sonication, please go to the Option Screen.** Check the Footswitch option and even if you are not using a Footswitch, make sure it is set on the first option as shown below.

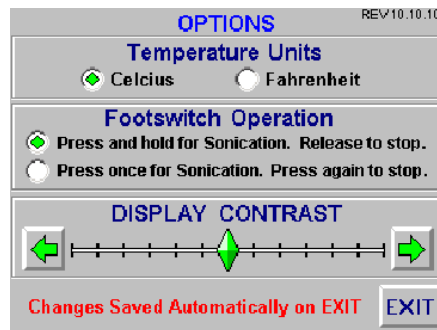

**Note:** Do not run a diagnostic test with a Cup Horn or Microplate horn (see page 24).



Typical Error screens

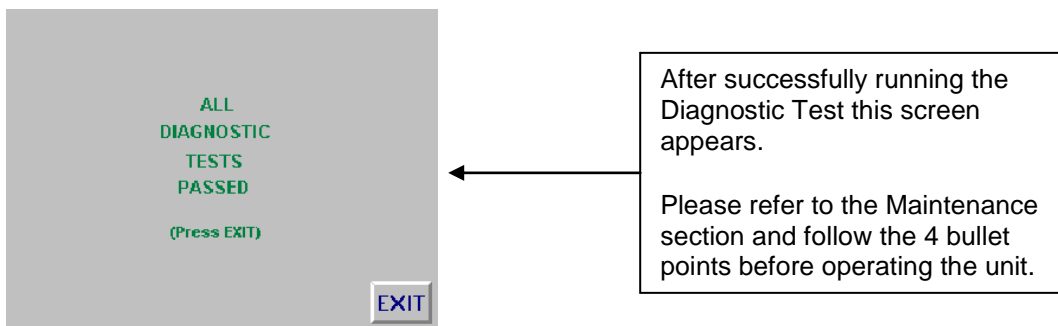

**Note:** Most faults can be solved by cleaning all mating and threaded surfaces using isopropyl

alcohol and properly re-assembling tightly together using the appropriate wrenches.

**Note:** If the display freezes, switch Off main power, wait 5 seconds and switch back On.

**Note:** If you touch Start and sonication does not occur, switch Off main power, wait 5 seconds and switch back On.

If these steps do not solve your problem, you must visit our website at [www.sonicator.com](http://www.sonicator.com) and fill out our brief **Repair Form**. This form provides us with the necessary information to quickly diagnose your problem and will speed up the repair of your equipment.

This form **must** be submitted before speaking with our service department. After the review of your form, you will be contacted by QSonica. If your unit requires service, QSonica will e-mail you a Return Material Authorization (RMA) number. Further details about the repair process can be discussed after you submit the **Repair Form**.

## **12. Warranty**

QSonica warrants each product manufactured by it to be free from defects in material and workmanship under normal use and service for 2 years. QSonica's obligation under this warranty is limited to the repair or replacement at its sole option of any product or part thereof, which has been returned to it after shipment of the product to its original purchaser and which examination discloses, to QSonica's satisfaction, that the product is defective.

Horns, Tips and Microtip™ probes are disposable items. These accessories wear out under normal usage and require periodic replacement.

Microplate Horns have a one-year warranty free from defects in material and workmanship under normal use and service.

The obligation of QSonica under this warranty will be to make any repair at its plant in Farmingdale, New York, or at any of its designated service centers, without charge, including parts and labor, but not including shipping charges, necessitated by any defect in workmanship or material.

This guarantee is in lieu of any warranty of any kind or nature including fitness for any particular application under the Uniform Commercial Code or any other statute, regulation, court decision, or otherwise. QSonica shall not be responsible for any consequential damages.

Discoloration of paint due to exposure to the lab environment and normal wear and tear is not covered under this warranty.

This warranty shall **not apply** to any product or replacement part which has been subjected to any damage as a result of an accident or abuse, or that has not been used and maintained in accordance with the information contained in the literature accompanying the product or that has been modified, repaired or serviced by any person or company other than QSonica or its authorized representative.

### **13. Return of Equipment**

All requests for repairs and replacement parts should be directed to the Customer Service Department at QSonica following the outlined procedure below.

1. Go to [www.sonicator.com](http://www.sonicator.com) and click on the **Contact Us** section. Follow the troubleshooting procedures. If troubleshooting does not fix your problem you must fill out a **Repair Form**. This form helps us diagnose the equipment and speeds up the repair process.
2. After submitting a **Repair Form** online we will contact you with a RMA (Return Material Authorization).
3. *No returns are accepted without an RMA number.*
4. When sending in equipment, always include the generator, converter, cables and horns.
5. Equipment should be returned in the original packaging.

#### **Packaging**

If you don't have the original packaging, it can be purchased by ordering the following:

Foam: # U2001A4000, U2002A4000 (both are needed)  
Box: # U2000A4000, U2000A0CL4 (both are needed)

The total cost for the boxes and foam is \$50.00 including shipping to any US location.

QSonica is not responsible for shipping damage on equipment returned to our facility for repair. It is highly recommended that you purchase approved packaging if you do not have your original box. If you choose not to use original packaging, you must pack each item separately with substantial amounts of foam and packing materials to prevent damage. Damage that occurs from shipping is not covered by the unit's warranty.

#### **Important Notice**

BY RETURNING ANY MATERIAL TO QSONICA, THE CUSTOMER OR THE CUSTOMER'S AGENT THUS CERTIFIES THAT ANY AND ALL MATERIALS SO RETURNED ARE, OR HAVE BEEN RENDERED, FREE OF ANY HAZARDOUS OR NOXIOUS AND/OR INFECTIOUS MATTER OR RADIOACTIVE CONTAMINATION AND ARE SAFE FOR HANDLING UNDER NORMAL REPAIR SHOP CONDITIONS. **DO NOT** RETURN ANY MATERIAL, FOR WHICH SUCH CERTIFICATION CANNOT BE MADE WITHOUT PRIOR APPROVAL FROM QSONICA

The correct return address should read as follows:

**QSonica LLC**  
**RMA # \_\_\_\_\_**  
**53 Church Hill Road**  
**Newtown, CT 06470**

## **14. Instructions for Specialty Horns**

### **Cup Horn Instructions**

1. Ensure rubber splash shield is securely placed under the cup.
2. Install and hand tighten the cup horn onto the converter. Then tighten the horn with the pin spanner wrenches.
3. The Sound Enclosure holds the Cup Horn securely. See Sound Enclosure instructions for details. If you do not have a Sound Enclosure, a strong lab stand using two clamps on the **converter case** can be used. See page 13 if using a clamp.
4. Install fittings (plugs and/or hose adapters) to inlet, outlet and overflow ports. Teflon tape may be used if fittings leak. Check alignment of O-rings to make sure they are straight.
5. Water should be filled up to the midpoint between the top of the horn and top of the acrylic cup. Please allow room for displacement when sample is added.

For constant flow cooling, use hose adapters with soft tubing. Provide pinch clamps on the inlet and outlet tubes to control flow. An open-bath re-circulating chiller is recommended for maximum cooling. The flow required is about 500 ml/min. Place a flat plate on the cup to avoid splashing if the coolant flow is turned too high.

For static cold water use, close off all three ports with the plugs provided and fill the cup. If sonication is brief, the heat generated in the cup is insignificant to affect the sample. If the water temperature rises, pour it out and refill the cup with cold water.

Another method of operation is to fit the outlet port with the hose adapter, soft tubing and a pinch clamp. Run the tubing, without bends or loops, directly to a drain. Add ice and water to the cup. After the ice melts, drain the cup and refill with ice and water. If the fittings leak, place Teflon tape around the fitting threads. If coolant splashes into the shield, tip the shield edge to drain it.

If you decide to use ice, it must be on the sides of the cup and not below your samples. Acoustic energy travels throughout the area above the horn. The presence of ice can block the transmission of energy, reducing its effectiveness.

*For maximum transmission of acoustic energy into the sample vessel, use a cavitation-resistant fluid such as a water-glycol mixture, pure ethylene or propylene glycol. The sonication intensity will be greatly increased, in proportion to the glycol concentration. If using tap water, you should degas the water before adding your samples.*

### **Cup Horn Operation**

Cup Horns are high intensity ultrasonic water baths that allow samples to be processed in completely closed containers (such as test tubes or vials). The ultrasonic probe never comes in contact with sample so that sample loss, escape and/or cross contamination cannot occur. Larger Cup Horns allow for the simultaneous sonication of clusters of tube or vials providing for uniformity of processing. Cup Horns are ideal for sterile or pathogenic sample

processing. Three different sizes are available.

Most laboratory grade plastic or borosilicate glass vessels that will fit into the cup are suitable for sonication. Polystyrene and polycarbonate are the best transmitters of acoustic energy. Polypropylene and polyethylene are softer and may be less effective. Glassware must be free of any scratches and fully annealed or it may over stress and crack.

Ultrasonic energy is radiated directly upward through the vessel while transmission through the side is negligible. For this reason, flat-bottomed vessels are best and round bottomed are next best. Vessels should have thin, uniform bases, without any heavy edges or centers. Conical tubes should be tilted to expose maximum sample area to the horn. Samples should be wide and shallow, rather than tall and narrow. Maintain a small clearance around the vessel to allow adequate coolant flow.

Energy transmission to the sample vessel can be determined easily by the pattern of sonication (cavitation bubbles or micro streaming) in the coolant. At low levels, the bubbles will usually appear as a dome of bubbles capping the coolant exit in the face of the horn. As the amplitude of the ultrasonic vibration (amplitude control knob setting) is increased, the bubble pattern will lift and become vertical diaphanous streams in the center of the cup, sometimes forming a spider-like pattern.

### **Output (Amplitude) Settings**

When working with small samples there is a tendency to turn the Amplitude setting too high. Doing so may cause the ultrasonic energy to go around the vessel, not through it.

It is important to run the unit and look at the sonication field before you use the unit on actual samples. Notice the tiny bubbles traveling through the liquid. The action above the Horn may resemble a mini tornado. As you increase the amplitude setting you will see that the intensity of the sonication increases and actually moves higher through the liquid.

Sample height above the horn should loosely correspond to the amplitude setting. The closer the samples are to the horn, the lower the setting should be used.

At high settings it is possible to generate so many cavitation bubbles that the Horn creates an air pocket where energy will not be effectively transferred. Too much amplitude will reduce the effectiveness of the sonication inside your vessel by expending too much energy in generating cavitation outside the vessel. Lower amplitude settings are recommended for the Cup Horn.

### **Cup Horn Maintenance**

The cup is made of acrylic plastic and should be cleaned periodically with a mild detergent like soap and water. Do not clean with solvents or abrasives. The horn is a tuned resonant body of titanium alloy. Do not attempt to resurface the horn if it shows erosion after extended use.

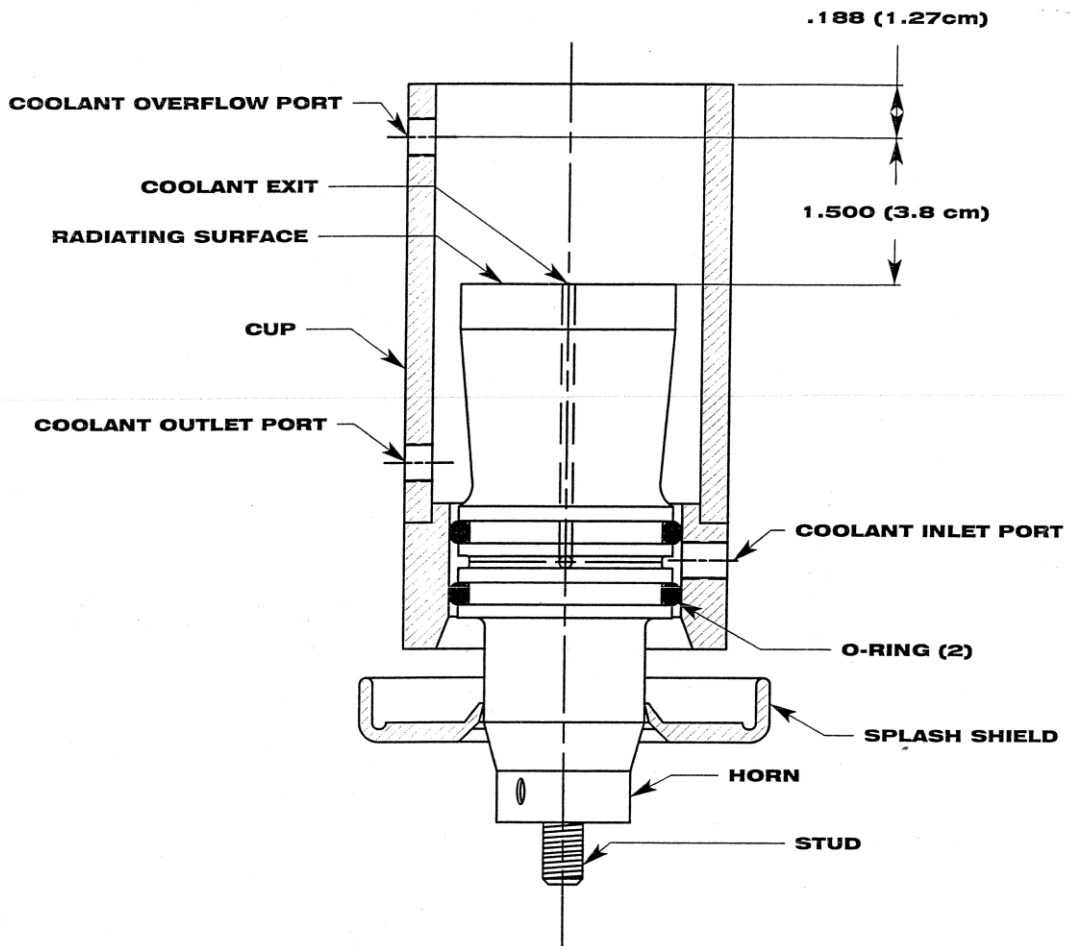

**SPECIFICATIONS:**

**OVERALL LENGTH: (APPROX) 7 1/4" (18.4cm)**

**OUTSIDE DIAMETER: 3" (7.6cm)**

**INSIDE DIAMETER: 2 1/2" (6.4cm)**

**RADIATING FACE DIAMETER: 2" (5.1cm)**

**COOLANT PORT 1/8" NPT (FITTINGS SUPPLIED)**

**CONNECTING STUD: 3/8-24**

## Microplate Horn Instructions

The Microplate Horn is a large, 6" diameter horn capable of processing a variety of sample sizes. An entire microtiter plate or several microtubes can be sonicated at one time.

A liquid media, such as water or glycol, is used to transmit the ultrasonic energy from the horn's surface to the sample. A rack of tubes or a standard 96-well microplate can be easily processed. Simply place your samples within the water filled reservoir and the sonic energy is transferred into each individual well or tube. This unit is ideal for high throughput applications.

The Horn is equipped with a clear acrylic collar to contain the liquid media within the reservoir. This format allows the user to process deep well microplates or other large vessels. Standard microtiter plates or pcr tubes require a smaller volume of liquid for sonication. For these applications, the clear acrylic collar may be removed and the lower, gray collar will allow for easier access to the samples.

### Protein Misfolding Cyclic Amplification Assay (PMCA)

The Microplate Horn is used in PMCA research. A tube holder and cover (#444) are available for proper sample positioning. Please specify if you intend to use the unit for PMCA when contacting QSonica.



**S-4000MPX**



Microplate Horn  
with 1.5 ml tubes  
in a foam rack.



# 444 PMCA  
Adapter

### Set-up

Attach and tighten the Horn to the converter using the pin spanner wrenches. Figure 1 shows how to

tighten the horn. Figure 2 shows how to loosen the horn. After the horn has been tightened, check the alignment of the plastic collars. Ensure the plastic collars are lined up properly on the o-rings and not installed on an angle. If the collars are not on correctly, the horn may leak water.



**Figure 1**

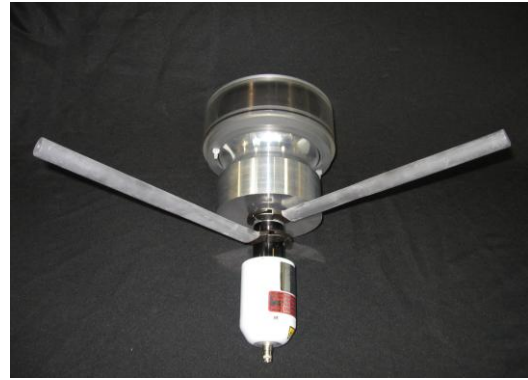

**Figure 2**

Each Horn is shipped with an Acoustic Enclosure to reduce the sound produced by sonication (see figure 3). The converter cable must first be inserted through the bottom of the sound enclosure before attaching it to the Horn/Converter assembly. Pull the converter cable through the opening at the bottom of the Acoustic Enclosure. Connect the cable to the converter and slowly feed the cord down, through the bottom of the enclosure until the converter sits properly in the holder (be sure that when placing the horn in the box the cable does not become stuck under the horn).



**Figure 3**

Two pieces of Tygon tubing are included with the Horn. See the Horn Diagram on page 48. Slide the pinch clamps provided, onto the tubing. Attach the tubing to the hose barb fittings on the bottom of the Horn adapter (grey plastic rim around the microplate horn). Pass the tubing through the holes in the bottom of the acoustic enclosure. Close the pinch clamps on the tubing so that water can be held in the Horn reservoir and not leak out. Open the pinch clamps if you are using a pump to circulate cold water.

**Note:** The tubing can be connected to a device, such as a peristaltic pump to re-circulate cold water through the Horn reservoir, this is described below. This tubing is commercially available and you will need to purchase longer pieces of tubing for this process.

### **How to fill the Horn reservoir for sample processing:**

For standard microplates: Be sure the tubing attached to the Horn is clamped shut. Fill the Horn reservoir with **140 ml** of water.

For Deep Well microplates or microtubes: Be sure the tubing attached to the Horn is clamped shut. Fill the reservoir with **350 ml** of water.

Attach the cable from the converter to your Sonicator unit.

### **Choosing a Microplate**

Using the proper type of microplate is critical to obtaining optimum, reproducible results. Please select a type of microplate that meets the following criteria:

Each individual well on the microplate must be exposed to water on all sides for optimum sample processing.

Flat bottom plates are not recommended for 96 well plates. Larger samples, such as 6 well plates will process well since more surface area is in contact with the ultrasonic energy. Plates with chimneys or holes on the skirt that allow air pockets to vent are ideal.

**Special Note:** *Ultrasonic energy does not pass through air, it requires a liquid medium to be transmitted effectively. If air pockets are present and water is not in contact with the bottom and side of each well, sonication will be inefficient and your results will vary.*

If you have a particular type of microplate that does not meet all of the above stated criteria, we recommend you prepare your microplate so it will sonicate at optimum levels. You may need to cut a notch out of the side of the plate to allow water to fill the area under the plate. This will also help to let air bubbles out.

Use small needle-nose pliers or nail clippers to snip a piece of the microplate at one or more of the sides. This should be a tiny piece no bigger than 10mm and only at the lowest ridge of plastic.

### **Keeping Your Sample Cool**

The Horn generates a significant amount of heat that may affect the ability to obtain optimum results and performance. Circulating cold water through the Horn reservoir is highly recommended.

**Note:** If you add ice to the reservoir, be sure that the ice is not under your samples. Ice will reduce the transmission of ultrasonic energy.

QSonica recommends the use of a Chiller or a Peristaltic Pump with a dual head that allows two pump-heads on one pump or drive motor. It should be rated at a minimum of 40ml per minute. Attaching a circulator or water pump directly to the tubing attached to the portholes on the Horn will allow you to recirculate water throughout the reservoir.

## Operation

Ensure that there are no air bubbles under your samples.

As with any Sonicator application, the amplitude setting is subjective and may vary with each user's particular application. Most users have found their best results while running the MPH at or above amplitude setting 5. It is recommended to start optimizing your procedure at low settings and increase amplitude as needed.

If you are experiencing atomization from the microplate wells, cover with a lid or seal with plastic film type cover. The sealing film is especially advantageous for microplates with wells filled to their maximum level.

If you are sonicating for long time intervals, the horn and water will increase in temperature. You should test the water by touch after each sonication interval is complete. If the water is too warm, replace it with ice cold water. Programming the Sonicator to "pulse" mode will also aid in keeping the temperature of the horn and the water cool. Circulating cold water through the reservoir is highly recommended.

All sonication times are application dependent. Always start at low amplitude settings and short time frames. Increase your processing times and amplitude settings as necessary until you achieve your desired results. The optimum scenario is to re-circulate ice-cold water with pulsed sonication.

## Maintenance

To ensure optimum performance it is highly recommended to remove the horn from the converter and clean the mating surfaces on a regular basis. The horn and converter are joined by a threaded stud. The vibration of the device causes stress and friction inside this connection. Disassemble the unit with the wrench set, cleaning the threading and hole with a cotton swab dipped in alcohol. Wipe the flat mating surfaces with alcohol. Let the parts air dry and reassemble tightly with the wrench set. This preventive maintenance should be done weekly.

The top surface of the MPH can be cleaned with a mild soapy solution and rinsed. Do not use solvents or abrasives to clean the microplate horn. Do not allow water to drip into the Converter (located below the horn). Water can damage the Converter and cause down time. Water damage is not covered by the warranty.

**Important Note:** When the unit is not in use, drain water and dry the surface of the horn. The Horn is made of aluminum, and with use, you will notice a blackening or staining of the surface of the horn. This is due to normal oxidation of the aluminum. Oxidation stains may be apparent on brand new units since each unit is tested before it is shipped. This staining/blackening has no effect on the performance of the Horn and the stain may eventually fade (but not completely go away) over time.

## Microplate Horn Diagram (#431MPX)

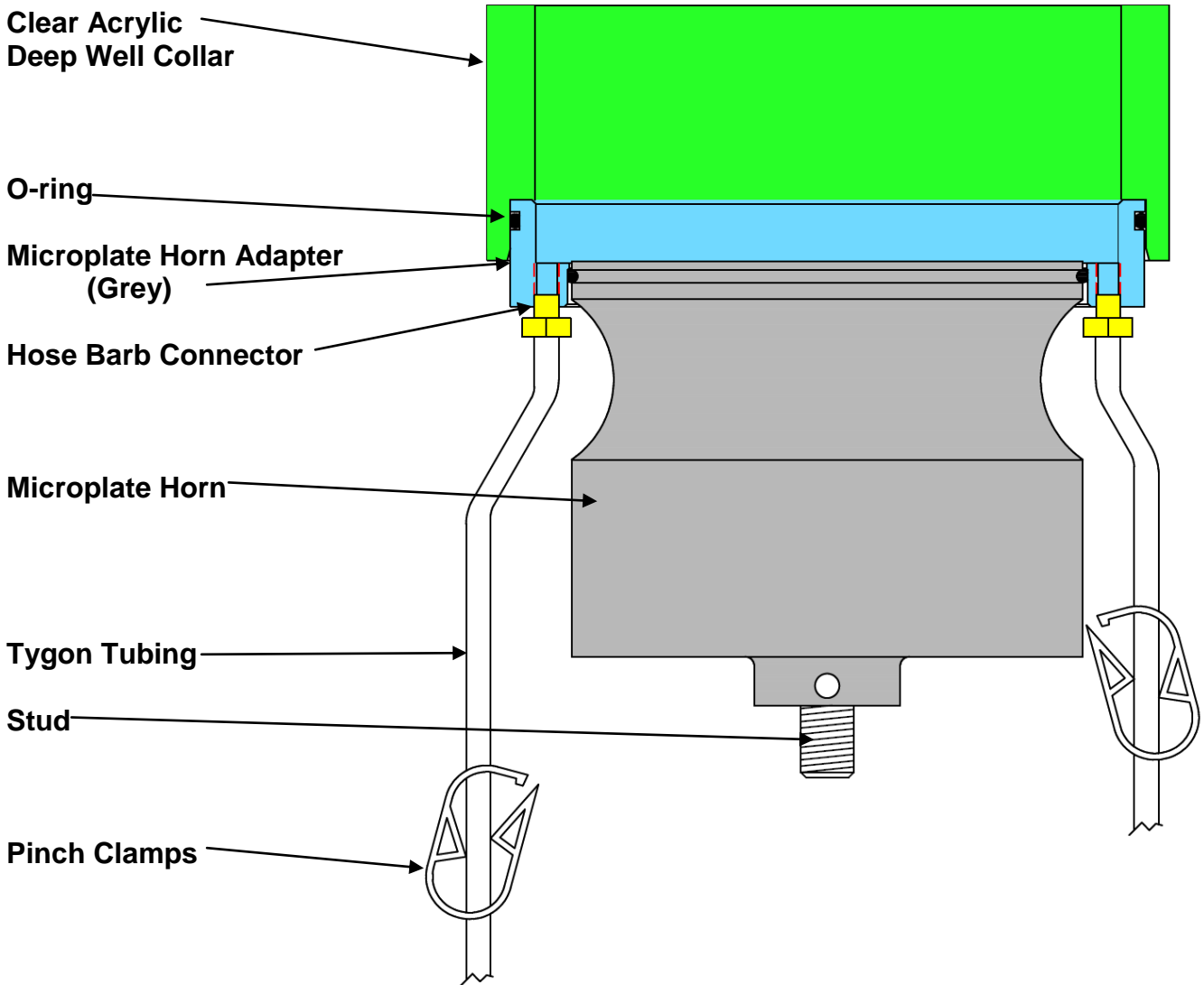

- The tall, clear collar is removable. If it is not required, simply slide it upwards and it will be released.
- The Sound Enclosure is included with the purchase of the # S-4000MPX or # 431MPX.
- If you only purchase # 431MPX, the Generator and Converter are not included.

## **Suggested Microplates, Pumps and Chillers and where to buy them:**

### **Microtiter Plates**

#### **96 shallow-well microplate:**

- 96-well Full Skirt PCR plate, 2ml, part #285096. Manufacturer: E&K Scientific (1-800-934-8114)
- Hard Shell™ Skirted Microplate, 96-well, part # HSP-9601. Manufacturer: MJ Research (1-888-729-2165)
- 96-well Skirted Plate, part # 652270. Manufacturer: Greiner Bio-one (1-800-884-4703)
- Thermal Cycler Plate, 0.2ml, part # UP 2312. Manufacturer: United Laboratory Plastics (1-800-722-2499)
- 96-23II reaction plate, part # N801-0560. Manufacturer: Applied Biosystems (1-800-327-3002)

#### **384-well microplate:**

- 384-well Polypropylene, small volume, part # 785201. Manufacturer: Greiner Bio-one (1-800-884-4703)

#### **1536-well microplate:**

- 1536-well Polypropylene, part #782270P. Manufacturer: Greiner Bio-one (1-800-884-4703)

#### **Deep-well microplate (the first two are the most recommended since they have vents):**

- 96-well Masterblock Deep-well, part #780201. Manufacturer: Greiner BioOne (1-800-884-4703)
- Cluster Tube System, 1.2ml tubes, part #4412. Manufacturer: Corning (1-800-492-1110)
- Assay Block, 96-well, 0.5ml PP, part #3957. Manufacturer: Corning/Costar (1-800-492-1110)
- Assay Block, 96-well, 1ml PP, part #3959. Manufacturer: Corning/Costar (1-800-492-1110)

### **Chillers & Peristaltic Pumps**

#### **Thermo Fisher Catalog Chillers:**

- Catalog #13-874-7, Model 3006, capacity 6L
- Catalog #22-037-157, Model WK-230 (Benchtop chiller), capacity 6L

#### **Thermo Fisher Peristaltic Pumps:**

- Watson-Marlow PumpPro, Catalog #14-283-2 (Standard), Catalog #14-283-3 (Economy), NOTE: ask for two pump heads
- Manostat "Carter" Multichannel Pumps, Catalog #13-875-241. NOTE: ask for 2 channels that will fit size 16 tubing or 1/8" ID tubing.

#### **Cole Parmer Catalog Chillers:**

- High-Stability Digital Bath, Catalog #A-12108-00 (Analog), #A-12108-01(Standard), #A-12108-20 (Digital), capacity 6L
- Julabo Refrigerated Circulating Baths, Catalog # [EW-15002-00](#) (Economy), Catalog [EW-15002-04](#) (Digital), capacity 4.5L

#### **Cole Parmer Catalog Peristaltic Pumps:**

- Pump Heads (need 2) – Easy Load Pump Heads, Catalog #A-07518-00 for CRS rotor, PSF housing, Catalog #A-07518-10 for SS rotor, PSF housing, Catalog #A-07518-60 for SS rotor, PPS housing
- Pump Heads (need 2) – Easy Load II Pump Heads, Catalog #A-077200-50 for CRS rotor, PSF housing, Catalog #A-077200-60 for SS rotor, PSF housing, Catalog #A-077201-60 for SS rotor, PPS housing
- Pump Head (need 1) – Two channel Easy-Load II Pump Head, Catalog #A-77202-50 for CSR rotor, Catalog #A-77202-60
- Pump Drive – L/S Variable speed Economy Console Drive, Catalog #A-07554-80, 7 to 200rpm For the peristaltic pumps you'll need to use size 16 tubing or 1/8" ID tubing.

## 800A Flozell™ Instructions

The 800A allows you to see the liquid level inside the unit. The material of the body tube is polycarbonate and is resistant to most dilute acids and bases, oils, aliphatic hydrocarbons, ethers and alcohols. It may be attacked by strong alkalis, aromatic or halogenated hydrocarbons, or low molecular weight aldehydes. Do not exceed 50 psi pressure.

### Set-up Instructions

1. Three ¼" NPT hose fittings and three ¼" NPT plugs are supplied.
2. Do not use the two body ports as both inlet and outlet.
3. Flow must be directed through the orifice. Select the appropriate size orifice and install it into the Flozell™ with a # -014 size O-ring in the orifice holder.
4. Assemble the orifice with the stepped side away from the holder, projecting through the knurled orifice retainer ring. Hand tighten retainer ring onto orifice holder.
5. Assemble a -026 size O-ring onto the holder and wet the O-ring and the mating surface on the inside of the Flozell™ body.
6. Use care in assembling the holder to the body to prevent stripping the first threads or cutting the -026 size O-ring, screw it in 3-5 turns.
7. Similarly, wet the -220 size O-ring in the other end of the body and the mating surface of the Horn and fit the body over the Horn.
8. Screw the Flozell™ body around the ½" Horn until the end of the horn thread contacts the orifice plate and then **back it off 1 full turn.**
9. The Flozell™ should not be tightened on the horn or it will dampen the ultrasonic vibrations.
10. Screw in the orifice holder assembly until it contacts the Horn, **then back it off 2 full turns.**
11. Install inlet fittings into orifice holder and outlet and overflow fittings into Flozell™ body.
12. Connect soft plastic inlet and outlet tubing to the fittings provided, with valves as required.
13. Valves should be installed at the outer ends of the tubing to minimize the weight hanging from the horn.
14. Test the completed assembly for leakage before pressurizing or pumping liquid through.

Flow can be in either direction if only one inlet is used. It may be more advantageous to direct flow upwards through the orifice holder and out through the body fitting. Flow must be from the body toward the orifice holder if two inlets are used.

Orifice retainer and holder are stainless steel and have very fine threads shipped with a light film of machine oil to prevent galling. If the oil film is removed with the use of solvents or any other means, apply molybdenum disulfide, powdered Teflon, graphite or other appropriate lubricant.

## 800B Flozell™ Instructions

The material of the body tube is stainless steel and is resistant to most dilute acids and bases, oils, aliphatic hydrocarbons, ethers and alcohols. Strong acids are not recommended. Do not exceed 100 psi pressure.

### Set-up Instructions

1. Three ¼" NPT hose fittings and three ¼" NPT plugs are supplied.
2. Do not use the two body ports as both inlet and outlet.
3. Flow must be directed through the orifice. Select the appropriate size orifice and install it into the Flozell™ with a # -014 size O-ring in the orifice holder.
4. Assemble the orifice with the stepped side away from the holder, projecting through the knurled orifice retainer ring. Hand tighten retainer ring onto orifice holder.
5. Assemble a -026 size O-ring onto the holder and wet the O-ring and the mating surface on the inside of the Flozell™ body.
6. Use care in assembling the holder to the body to prevent stripping the first threads or cutting the -026 size O-ring, screw it in 3-5 turns.
7. Similarly, wet the -220 size O-ring in the other end of the body and the mating surface of the Horn and fit the body over the Horn.
8. Screw the Flozell™ body around the ½" Horn until the end of the horn thread contacts the orifice plate and then **back it off 1 full turn.**
9. The Flozell™ should not be tightened on the horn or it will dampen the ultrasonic vibrations.
10. Screw in the orifice holder assembly until it contacts the Horn, **then back it off 2 full turns.**
11. Install inlet fittings into orifice holder and outlet and overflow fittings into Flozell™ body.
12. Connect soft plastic inlet and outlet tubing to the fittings provided, with valves as required.
13. Valves should be installed at the outer ends of the tubing to minimize the weight hanging from the horn.
14. Test the completed assembly for leakage before pressurizing or pumping liquid through.

Flow can be in either direction if only one inlet is used. It may be more advantageous to direct flow upwards through the orifice holder and out through the body fitting. Flow must be from the body toward the orifice holder if two inlets are used.

Orifice retainer and holder are stainless steel and have very fine threads shipped with a light film of machine oil to prevent galling. If the oil film is removed with the use of solvents or any other means, apply molybdenum disulfide, powdered Teflon, graphite or other appropriate lubricant.

## 800C Flozell™ Instructions

The material of the body tube is stainless steel and is resistant to most dilute acids and bases, oils, aliphatic hydrocarbons, ethers and alcohols. Strong acids are not recommended. Do not exceed 100 psi pressure.

### Set-up Instructions

1. Clean Flozell™ and all metal parts. All metal parts of the Flozell™ are made of 300 series Stainless Steel. The horn is made of titanium. The o-rings and gaskets are made of BUNA-N (nitrile) material. *Ensure that this material is compatible with your sample/product.*
2. Install o-ring on the ultrasonic horn (if it is not already installed from the factory).
3. Connect horn to the converter. Tighten using the pin spanner wrenches, provided with your Sonicator system, as per the operating instructions.
4. Attach ½" hose barb NPT fitting to 'liquid out' port on side of the Flozell™ body (wrench tighten if necessary).
5. Attach ¼" NPT fitting to vent port on side of the Flozell™ body (wrench tighten if necessary).
6. Grease o-ring on horn lightly with silicone o-ring lubricant to ensure proper installation of the horn into the Flozell™ body.
7. Push horn into upper section of Flozell™ until fully seated.
8. Place 3" sanitary gasket on upper section (flange) of Flozell™ body.
9. Place each half of split upper ring over the gasket and ensure that the ring is seated properly on the gasket.
10. Place 3" sanitary clamp around upper section of the Flozell™ body and split ring, then hand tighten.
11. Thread flow tube into lower liquid inlet plate (wrench tighten tube if necessary).
12. Attach ½" hose barb NPT fitting to the 'liquid in' port (wrench tighten if necessary).
13. Place 3" Sanitary gasket on bottom of Flozell™ body.
14. Install lower liquid inlet plate, check that the lower inlet plate is seated properly on the gasket.
15. Place 3" sanitary clamp around bottom section of the Flozell™ body and lower liquid inlet plate, then hand tighten.
16. Attach plumbing or tubing to the 'liquid in' port, 'liquid out' port and 'vent' port.
17. Place Flozell™ in stand or clamp on a support. A clamp around the cell may be used.
18. Do NOT clamp on front driver of the converter.
19. Connect converter cable to converter and Sonicator generator.

DO NOT clamp in a manner that might cause misalignment on axial centerline of the Flozell™ and converter.

# IN-LINE PROCESSING

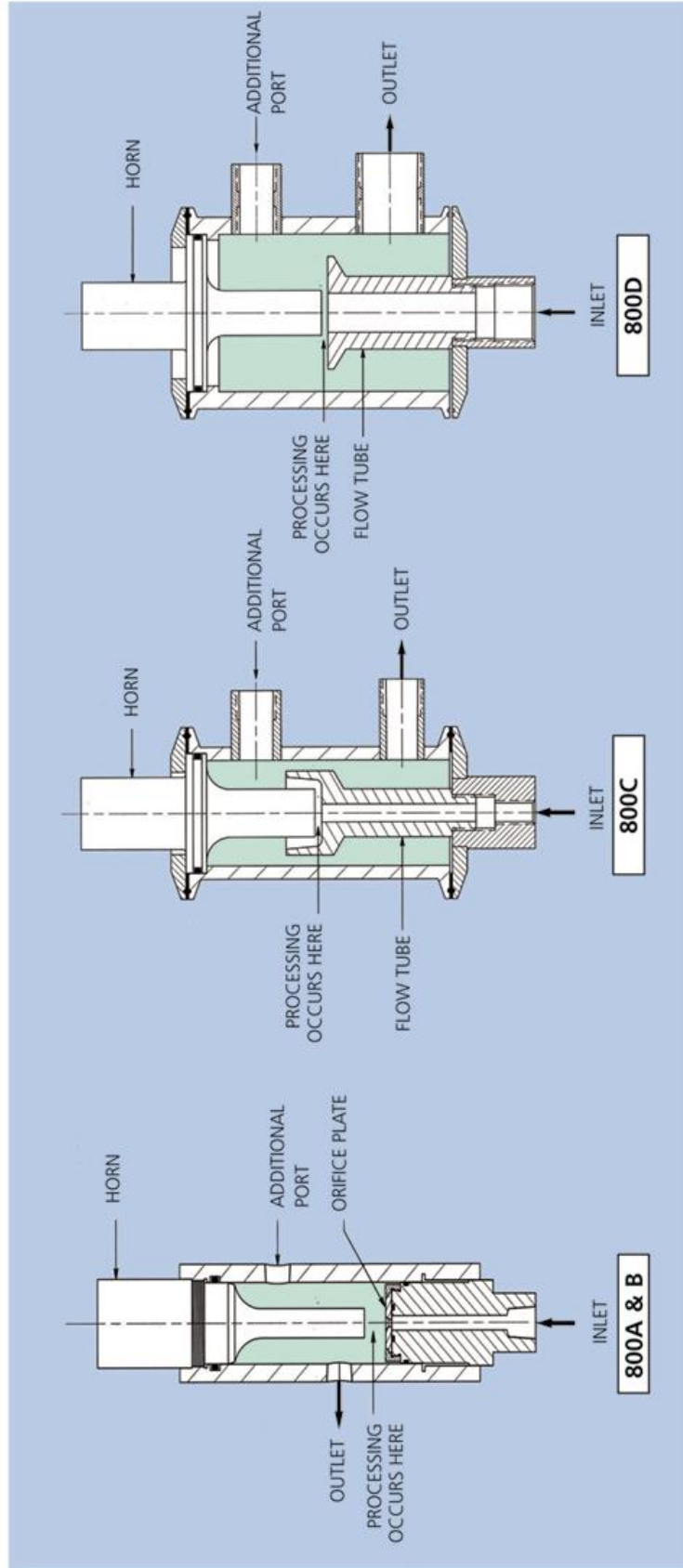

## Dual Horns

The dual horn is made up of three parts. The dual horn (part # 351) and two solid 3/4" extenders (part # 355).

These parts must be attached and tightened with the appropriate wrench set to ensure proper connection so the horn resonates at the proper frequency.

As with all horns, there must be clean, tight mating surfaces. Please refer to Maintenance section of this manual for direction on how to clean the threaded mating surfaces and ensure that the threaded studs are attached tightly to the horn.

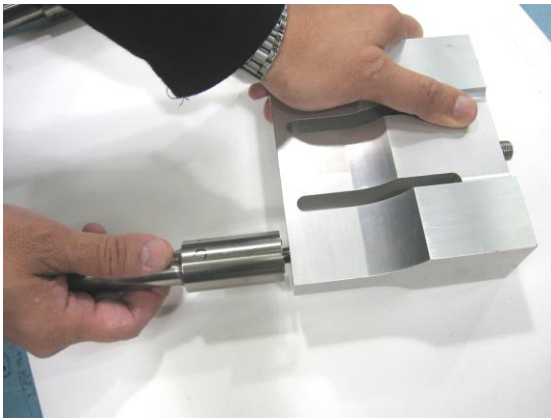

**Step 1:** Attach first 3/4" extender (part # 355) to the dual horn.

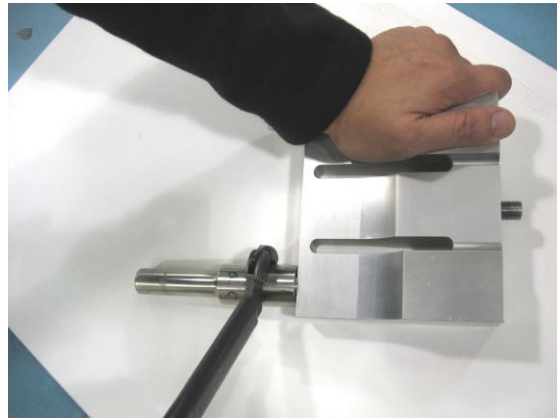

**Step 2:** Tighten the 3/4" extender with the pin spanner wrench provided with the Sonicator.

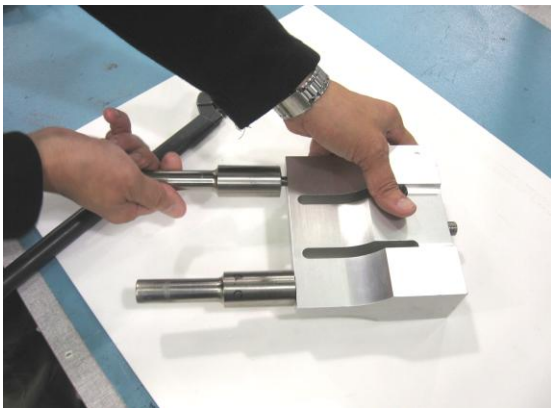

**Step 3:** Attach the second 3/4" extender (part # 355) to the dual horn.

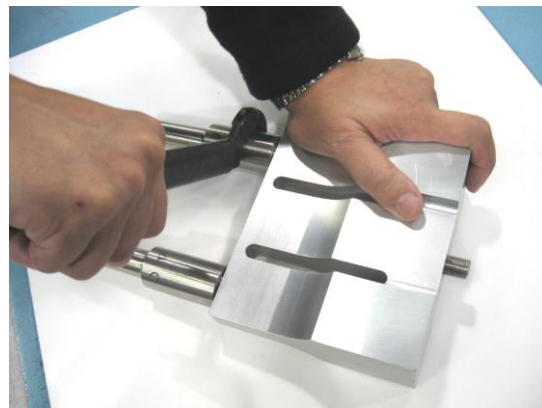

**Step 4:** Tighten the 3/4" extender with the pin spanner wrench provided with the Sonicator.

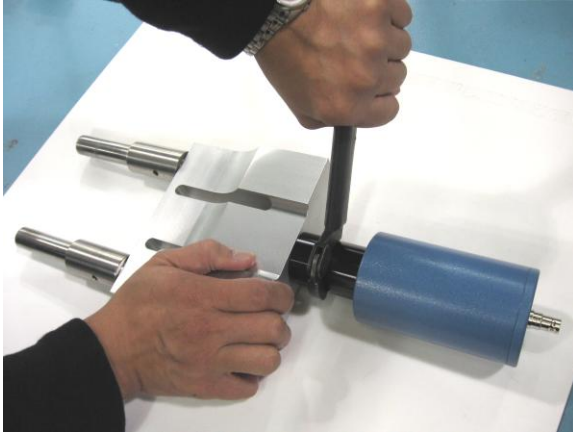

**Step 4:** Tighten the dual horn to the converter with the pin spanner wrench provided with the Sonicator.

If using a Sound Enclosure, please refer to the Sound Enclosure section of the manual for assistance with properly mounting the Dual Horn.

The  $\frac{3}{4}$ " extender horns are tested in pairs at the factory to ensure balanced operation and consistent output when used together. It is highly recommended to replace both horns at the same time. Mixing extender horns with other units is not recommended.